



# Application Guide BAC-5051AE router



**Includes installation, operation and maintenance instructions**

## Copyrights and trademarks

©2024, KMC Controls, Inc.

NetSensor, WinControl, and the KMC logo are registered trademarks of KMC Controls, Inc.

AppStat, BACstage, FlexStat, FullBAC, KMC Connect, KMC Connect Lite, KMC Converge, KMC Converge GFX, KMC Conquest, KMC Workbench, TotalControl, SimplyVAV, and the SimplyVAV logo are trademarks of KMC Controls, Inc.

All rights reserved. No part of this publication may be reproduced, transmitted, transcribed, stored in a retrieval system, or translated into any language in any form by any means without the written permission of KMC Controls, Inc.

Printed in U.S.A.

The material in this manual is for information purposes only. The content and the product it describes are subject to change without notice. KMC Controls, Inc. makes no representations or warranties with respect to this manual. In no event shall KMC Controls, Inc. be liable for any damages, direct or incidental, arising out of or related to the use of this manual.

## Handling precautions

This electronic device is sensitive to ESD (electrostatic discharge) that can cause the device to stop communicating.

To prevent damage from electrostatic discharges, take reasonable precautions when handling, servicing, or installing the router. Discharge accumulated static electricity by touching your hand to a securely grounded object before working with the router.



**KMC Controls, Inc.**  
19476 Industrial Drive  
New Paris, IN 46553  
U.S.A.  
TEL: 1.574.831.5250  
FAX: 1.574.831.5252  
[info@kmcontrols.com](mailto:info@kmcontrols.com)

<b>Contents</b> .....	<b>3</b>
<b>Section 1: Introduction</b> .....	<b>5</b>
<b>Specifications</b> .....	<b>5</b>
<b>Accessories and replacement parts</b> .....	<b>7</b>
<b>Mounting the router</b> .....	<b>8</b>
<b>Connecting for network routing</b> .....	<b>9</b>
<b>MS/TP network wiring</b> .....	<b>10</b>
<b>MS/TP EOL (End-Of-Line) termination switches</b> .....	<b>10</b>
<b>Connecting power</b> .....	<b>11</b>
<b>Single-cable connection</b> .....	<b>12</b>
<b>Maintenance</b> .....	<b>13</b>
<b>If you encounter difficulty</b> .....	<b>14</b>
<b>Safety considerations</b> .....	<b>14</b>
<b>Using the router as a technician's service tool</b> .....	<b>15</b>
<b>Section 2: Configuring the BAC-5051AE router</b> .....	<b>17</b>
<b>Initial setup</b> .....	<b>17</b>
<b>Setting up for configuration</b> .....	<b>18</b>
<b>Logging in</b> .....	<b>18</b>
<b>Changing your computer's address</b> .....	<b>19</b>
<b>Device properties</b> .....	<b>21</b>
<b>Time</b> .....	<b>22</b>
<b>BACnet Time Sync Networks</b> .....	<b>22</b>
<b>SNTP Time Server</b> .....	<b>23</b>
<b>Daylight Saving Time</b> .....	<b>23</b>
<b>Security</b> .....	<b>23</b>
<b>Session timeout</b> .....	<b>24</b>
<b>Section 3:</b> .....	<b>25</b>
<b>BACnet IP routing</b> .....	<b>25</b>
<b>BACnet Foreign device routing</b> .....	<b>26</b>
<b>BACnet Broadcast Management Device routing</b> .....	<b>27</b>
<b>Network address translation</b> .....	<b>28</b>
<b>Table</b> .....	<b>29</b>
<b>PAD routing</b> .....	<b>29</b>
<b>BACnet Ethernet routing</b> .....	<b>30</b>
<b>MS/TP configuration</b> .....	<b>30</b>
<b>Router Core properties</b> .....	<b>31</b>
<b>Home port</b> .....	<b>32</b>
<b>Routing properties</b> .....	<b>32</b>
<b>Section 4: Status and diagnostics</b> .....	<b>35</b>
<b>Routing Status</b> .....	<b>35</b>
<b>Routing Status buttons</b> .....	<b>36</b>
<b>Route Status list</b> .....	<b>37</b>
<b>Purging the Route Status list</b> .....	<b>39</b>
<b>Device Status</b> .....	<b>40</b>
<b>Operation</b> .....	<b>40</b>
<b>Token Use</b> .....	<b>42</b>

<b>Operation</b> .....	<b>42</b>
<b>MS/TP Metrics</b> .....	<b>43</b>
<b>Operation</b> .....	<b>43</b>
<b>Interpreting the diagnostic data</b> .....	<b>43</b>
<b>Description of the Metrics page</b> .....	<b>45</b>
<b>MS/TP Capture</b> .....	<b>46</b>
<b>Section 5: Advanced features</b> .....	<b>49</b>
<b>Recovering the network address</b> .....	<b>49</b>
<b>Updating the firmware</b> .....	<b>50</b>
<b>Configure from a file</b> .....	<b>51</b>
<b>Index</b> .....	<b>53</b>

# Section 1: Introduction

This section provides a description of the KMC Controls BAC-5051AE router. It also introduces safety information. Review this material before installing or operating the device.

---

## Topics in this section

Specifications .....	5
Accessories and replacement parts .....	7
Mounting the router .....	8
Connecting for network routing .....	9
Connecting power .....	11
Single-cable connection .....	12
Maintenance .....	13
If you encounter difficulty .....	14
Safety considerations .....	14
Using the router as a technician's service tool .....	15

## Specifications

Specifications are subject to change without notice.

---

### Communication ports

Two 10BaseT/100BaseT, RJ-45 connectors

#### BACnet MS/TP

One optically isolated MS/TP port, 9.6–115.2 kilobaud

Removable three-screw terminal block, 12–22 AWG wire

Switched end-of-line termination

#### USB

USB Type C connection for power and communications.

---

### Configuration and software

All configuration is through internal browser-based configuration pages. This requires an HTML5 browser.

---

## BACnet routing

BACnet IP—Two ports, each of which can be set up for any of the following protocols:

- Normal BACnet IP network routing
- BACnet broadcast management device (BBMD) with network and port address translation
- Foreign device registration with BACnet broadcast management devices (BBMDs)
- PAD (packet assembler/disassembler) routing

One BACnet Ethernet port

---

## Installation

Supply voltage	24 VAC (50/60 Hz) or 24 VDC; -15%, +20%; Class 2 only; non-supervised (all circuits, including supply voltage, are power limited circuits) 5 volts DC from powered USB connection Supply source automatically switches to highest available voltage 8 VA required power
Weight	Approximately 5.4 ounces (154 grams)
Case material	Green and black flame retardant plastic

---

## Processor and memory

Processor	Processor 32-bit ARM® Cortex-M7
Memory	Configuration parameters and diagnostics are stored in nonvolatile memory; auto restart on power failure

---

## Regulatory and agency listings

UL	UL 916 Energy Management Equipment  UL 864 Smoke Control Equipment listed (UUKL), 10th edition. For smoke control applications, see <a href="#">Smoke Control Manual for KMC Conquest Systems</a> , P/N 000-035-18.
RoHS	RoHS compliant (pending)
FCC	FCC Class A, Part 15, Subpart B and complies with Canadian ICES-003 Class A  This device complies with part 15 of the FCC Rules. Operation is subject to the following two conditions: (1) This device may not cause harmful interference, and (2) this device must accept any interference received, including interference that may cause undesired operation.

## Environmental limits

**Operating Temperature** 32 to 120° F (0 to 49° C)

**Shipping Temperature** -40 to 140° F (-40 to 60° C)

**Humidity** 0–95% RH, non-condensing

## Timekeeping

The BAC-5051AE router is a BACnet time master device.

Update interval	Daily, weekly, or monthly
Time message type	UTC, local, or both
Setting time	Synchronized to SNTP server, set from computer time, or manually entered

## Dimensions and mounting

Surface mount or 35 x 7.5 mm DIN rail mounting

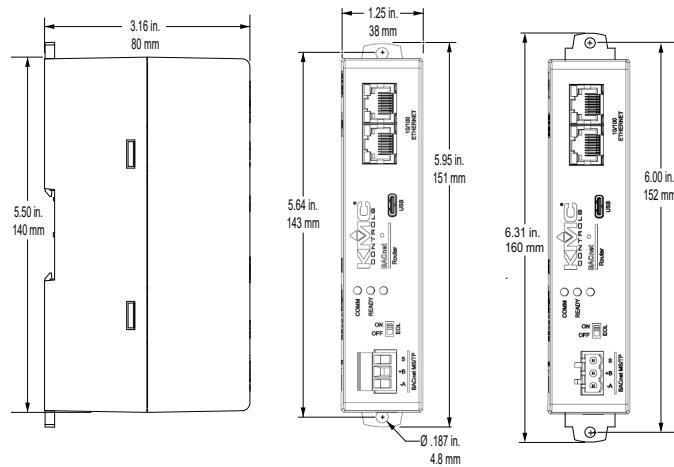

## Accessories and replacement parts

The following accessories and replacement parts are available from KMC Controls, Inc.

### Power transformer

[XEE-6111-50](#)

Transformer, 120-to-24 VAC, 50 VA, single-hub

[XEE-6112-50](#)

Transformer, 120-to-24 VAC, 50 VA, dual-hub

[XEE-6112-100](#)

Transformer, 120-to-24 VAC, 96 VA, dual hub (approved for smoke control applications)

### Surge suppressors

[KMD-5567](#)

EIA-485 surge suppressor for MS/TP networks

### Cables

[HSO-9001](#)

Ethernet cable, 50 feet

[HSO-9011](#)

Ethernet cable, 50 feet, plenum rated

## Replacement parts

[HPO-9901](#)

Controller replacement parts kit with terminal blocks and DIN clip

## Mounting the router

For permanent installations, the router can be flush mounted or snapped to a 35 x 75 mm DIN rail. For router dimensions, see the topic [Specifications on page 5](#).

**Surface mounting** Extend the mounting tabs away from the router body and fasten with screws.

### Illustration 1–1 Surface mounting the router

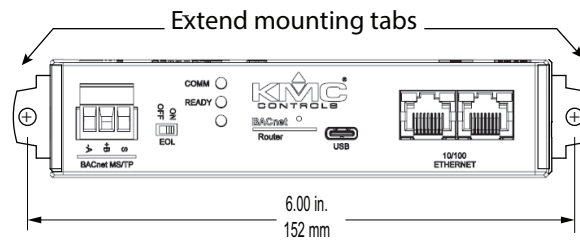

**DIN rail mounting** Mount the DIN rail and then do the following:

- 1 Extend the mounting tabs.
- 2 Place the bottom of the router over the DIN rail.
- 3 Push the mounting tabs back toward the router body to lock it to the rail.



## Connecting for network routing

For permanent installations, connect the BAC-5051AE router to a network router or network switch and an MS/TP network. For permanent installations, the router is typically connected to a 24 volt transformer for power.

For installations that include Internet access, install the router behind a firewall.

### Illustration 1–2 Permanent installation

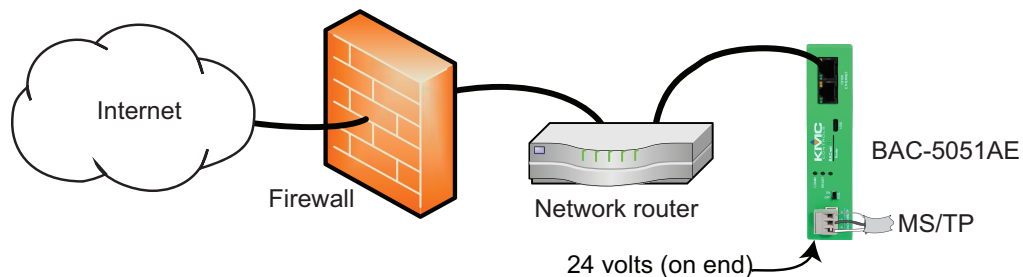

See also the following topics:

- [Mounting the router on page 8](#)
- [Connecting power on page 11](#)

## MS/TP network wiring

Use the following principles when connecting the router to an MS/TP network:

- Connect no more than 128 BACnet devices to one MS/TP network. The devices can be any mix of masters, slaves, or routers.
- Use twisted pair, shielded cable with capacitance of no more than 51 picofarads per foot for all network wiring. See the bulletin *TB190529A, EIA-485 Network Wire Recommendations* available at [kmccontrols.com](http://kmccontrols.com).
- Connect the *-A* terminal in parallel with all other negative (-) terminals.
- Connect the *+B* terminal in parallel with all other positive (+) terminals.
- Connect the shields of the cable together at each mid-line device. For KMC BACnet devices, use the *S* terminal.
- Connect the shield to an earth ground at one end only.
- Use a repeater between every 32 MS/TP devices or if the cable length exceeds 4,000 feet (1,220 meters). Use no more than four repeaters per MS/TP network.
- Connect a KMD-5567 surge suppressor to the MS/TP cable at the point where it exits a building.

### Illustration 1–3 MS/TP wiring

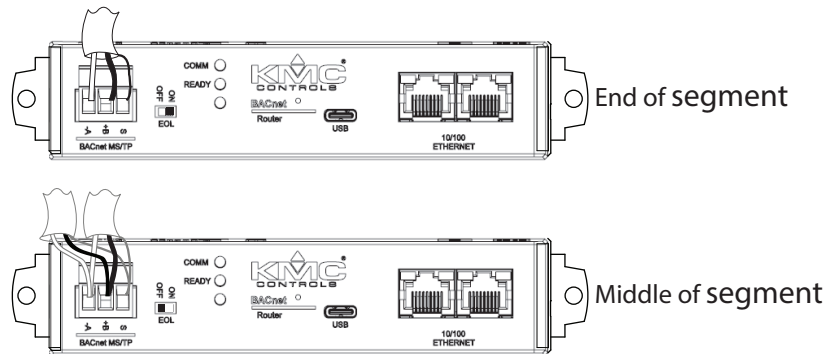

### MS/TP EOL (End-Of-Line) termination switches

Each controller at the physical end of an MS/TP wiring segment must have an end-of-line termination for proper network operation.

- If the router is at the end of the network segment, set the EOL switch to *ON*.
- If the router is in the middle of the network segment, set the EOL switch to *OFF*.

## Connecting power

Power the BAC-5051AE router from a 24 volt power source, either AC or DC, or from a USB connection. The router begins to operate when a power source is applied. Use the following guidelines when choosing and wiring sources to the router.

**For USB power** Connect the router to a powered USB port with a USB-C cable. Typically, the USB ports on laptop computers can supply power to the router. When connecting to a USB hub, verify the power specifications of the hub. See the topic [Specifications on page 5](#).

### Illustration 1–4 USB connection

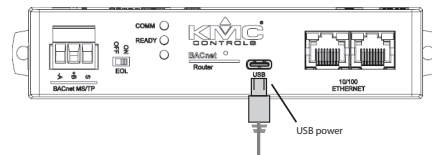

**Note:** When using USB connection for power and communications, use the USB cable from the HPO-5551 Technician's Router Cable Kit. The cable from the kit is specified to supply enough power for both the USB and the network connection.

To use the USB for power and network communications, see the topic [Single-cable connection on page 12](#).

For permanent installations, the router is usually powered from a 24 volt transformer or DC power supply.

### Illustration 1–5 24 volt power connections

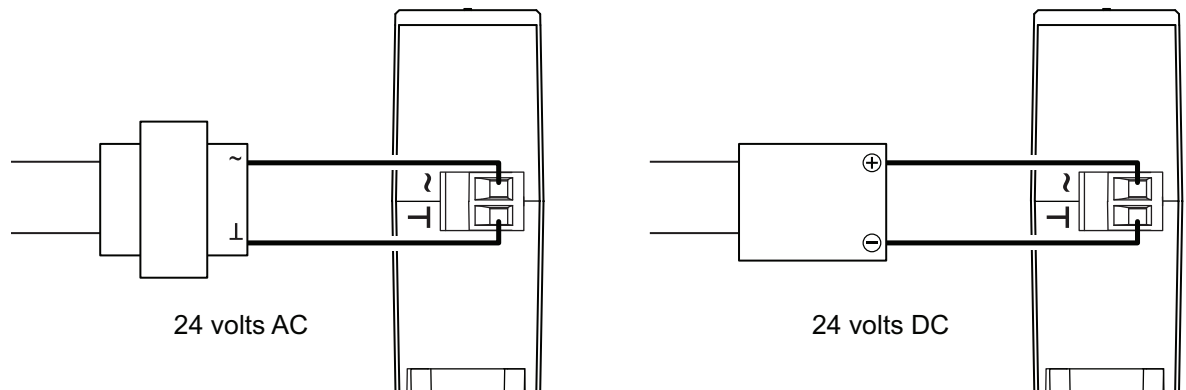

**For 24 volt AC power** Connect a 24 volt transformer to the black power terminal block on the end of the router.

- Connect the AC phase to the phase terminal (~).
- Connect the ground side of the transformer to the ground terminal (⊥).
- Use a Class 2 transformer of the appropriate size to supply power to the router.
- KMC Controls recommends powering the router from a dedicated transformer.
- Do not run 24 volt power from within an enclosure to external devices.

**For 24 volt DC power** Connect a 24 volt power supply to the black power terminal block on the end of the router.

- Connect the positive terminal (+) to the phase terminal (~).
- Connect the negative terminal (-) of the power supply to the ground terminal (⊥).
- Use a Class 2 power supply of the appropriate capacity to supply power to the router.
- KMC Controls recommends powering the router from a dedicated power supply.
- Do not run 24 volt power from within an enclosure to external devices.

## Single-cable connection

The single-cable connection method connects the BAC-5051AE router to a computer with a USB cable that supplies both power and communications. The USB port becomes a virtual network interface card (NIC) and establishes a network between the computer and the router.



**Note:** Use the USB cable from the HPO-5551 Router Technician's Cable kit for a single-cable connection. This cable meets the specification to supply the power and communications required by the router. Other cables may prevent routing on one or more ports.

**Illustration 1–6 Single-cable connection**

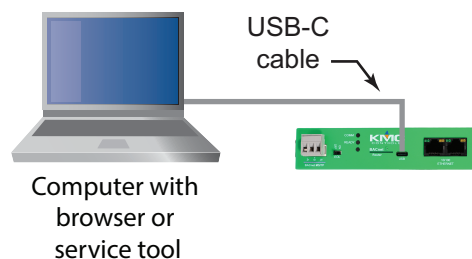

To set up a single-cable connection, do the following:

- 1 Plug the USB cable from the HPO-5551 cable kit into the router.

- 2** Plug the other end of the USB cable into the computer.  
Depending on the version of Windows, the first time the router is plugged into a computer, Windows will display a message that it is installing a new driver. Click the message to see more details. Note the name of the device in the message because you will need this information in later steps. Allow the installation to finish and then close the dialog.
- 3** From the Windows Control Panel, click **Network and Internet**.
- 4** Click **Networking Sharing Center**.
- 5** Once the center is open, click **Change Adapter Settings**.
- 6** Identify the Local Area Connection that is associated with the router and click it to open the connection.
- 7** In the Local Area Connection status, click **Properties**.
- 8** When the next dialog opens, choose **Internet Protocol Version 4**.
- 9** Click **Properties**.
- 10** In the Properties dialog, select **Use the following IP address** and then enter a unique IP address and subnet mask.
  - The IP address must be unique and be part of the same subnet as the router's address.
  - If the router is still configured with the default address, use 192.168.1.10.
  - Set the subnet mask to 255.255.0.0.
- 11** When finished, click **OK** to save the work and then close all dialog boxes.

To test the connection, do the following:

- 1** Open a browser window.
- 2** Enter the address of the router.
- 3** When the log in page opens, set up the router as described in the topic
- 4** When the log in page opens, set up the router as described in the topic .

## Maintenance

The BAC-5051AE router requires no routine maintenance. If necessary, clean with a damp cloth and mild soap.

## If you encounter difficulty

If you experience difficulty with the BAC-5051AE router, KMC Controls provides the following assistance.

**The KMC Controls web site** Navigate to the support section on the KMC Controls website for the latest information for BAC-5051AE router and other KMC Controls products.

[www.kmcontrols.com](http://www.kmcontrols.com)

**KMC technical support** Our distribution partners have unlimited and free access to our team of Technical Support representatives. We provide coast-to-coast and toll-free support from 8:00 AM Eastern Time to 5:00 PM Pacific Time.

Toll-Free Technical Support: (866) 303-4562

## Safety considerations

KMC Controls, Inc. assumes the responsibility for providing you a safe product and safety guidelines during its use. Safety means protection to all individuals who install, operate, and service the equipment as well as protection of the equipment itself. To promote safety, we use hazard alert labeling in this manual. Follow the associated guidelines to avoid hazards.



**Caution:** Caution indicates potential personal injury or equipment or property damage if instructions are not followed.



**Note:** Provides additional information that is important but may be missed.



**Tip:** Provides programing tips and shortcuts that may save time.

## Using the router as a technician's service tool

To use the BAC-5051AE router as a technician's service tool, connect it between a computer running a service tool program and a BACnet internetwork. Use the following cables from the HPO-5551 Router Technician's Cable kit to make the connections.

- The MS/TP to NetSensor cable
- The USB-C cable

**Illustration 1–7 Router service tool connection**

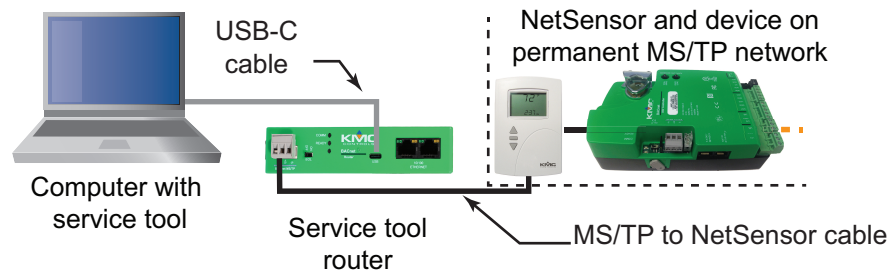

**Computer requirements** The computer running the service or configuration program must have a BACnet driver installed and be configured to match a port in the service tool router. The program also requires a unique Device Instance number assigned to the BACnet driver. The exact details for setting up the driver vary with each program.

**Router setup** Using the router for service connection requires that the router is set up with a unique Device Instance and network number between the computer and router. The network between the computer and router may be one of the IP protocols or the Ethernet protocol. Typically, the normal IP protocol is used when the router is connected between a computer and an MS/TP network.

- See the topic [on page 25](#) for details on configuring the router's ports for BACnet networks.
- Setting the device instance number is described in the topic [Device properties on page 21](#).

To set up the router for a service connection, do the following:

- 1 Set up the computer and router for a single-cable connection as described in the topic [Single-cable connection on page 12](#).
- 2 Connect the MS/TP to NetSensor cable between the router and the bottom of a NetSensor or STE-6000 sensor with a network port.
- 3 Assign a unique device instance number and network number to the service tool program.
- 4 Log in to the router using an HTML5 browser.
- 5 Assign a unique device instance number to the router.

- 6** Enable a port in the router for BACnet network.
  - The protocol for the port, either IP or Ethernet, in the router must match the protocol used by the service tool program.
  - The BACnet network number assigned to the port must be unique on the BACnet internetwork.
- 7** In the Router Core area, verify or select all of the following check boxes:
  - Route On Startup
  - Enable Routing
  - Use Learned Networks
- 8** Enable the MS/TP port in the service tool router.
  - Set the MS/TP MAC in the router that is unique on the MS/TP network.
  - Set the baud rate to match the baud rate of the building's MS/TP network.
- 9** Start the service tool program. The BACnet devices on the internetwork will be available for discovery. If it is a large internetwork, it may take a few minutes to discover all devices.



## Section 2: Configuring the BAC-5051AE router

This section provides important guidelines for configuring a router before it is placed on a network. Review this information carefully for proper installation.

---

The router must be configured as a network device. To prevent disrupting an existing network, configure the network address before connecting the router to the network. The BACnet device instance and other properties can be configured at the same time or after the IP address is assigned and the router is installed in its permanent location on a network.

### Topics in this section

Initial setup .....	17
Device properties .....	21
Time .....	22
Security .....	23
Session timeout .....	24

### Initial setup

Configure the BAC-5051AE router with an HTML5 compatible web browser using the web pages served from within the router. The router has the following default network address values.

- IP address—192.168.1.252
- Subnet mask—255.255.255.0
- Gateway—192.168.1.1

You will need the following information before you can configure a router.

From the BACnet system engineer:

- BACnet device instance for the router.
- Network numbers for each of the enabled networks.
- If applicable, the address and port for a PAD router or BBMD to which the router will connect.

From the IT system administrator:

- The IP address for the router.
- The IP subnetwork mask for the Ethernet LAN to which the router will connect.
- The IP address of the network gateway.
- If the router is part of a system that uses the Internet, you will also need the public IP address and port.

You will also need an HTML5-compliant browser, Ethernet cable, and a USB-A to USB micro cable or a 24 volt AC power source.

## Setting up for configuration

To configure the router, plug it into an Ethernet port. Typically, this is a direct connection to a computer Ethernet connection that requires changing the computer IP address. See the procedure [Changing your computer's address on page 19](#).

In addition to the Ethernet connection, supply temporary power to the router with a USB cable. An alternative to the USB power connection is a 24 volt AC source. See [Connecting power on page 11](#).

### Illustration 2–1 Connecting for configuration



## Logging in

Use an HTML5 browser to log in and configure the router.

To log in, do the following.

- 1 Connect the router to an Ethernet port by doing one of the following.
  - Connect directly to the computer.
  - Connect to a subnet that recognizes address 192.168.1.252.
- 2 Connect the router to either USB or 24 volt AC power.
- 3 Open a new browser window.
- 4 Enter the address **192.168.1.252**.

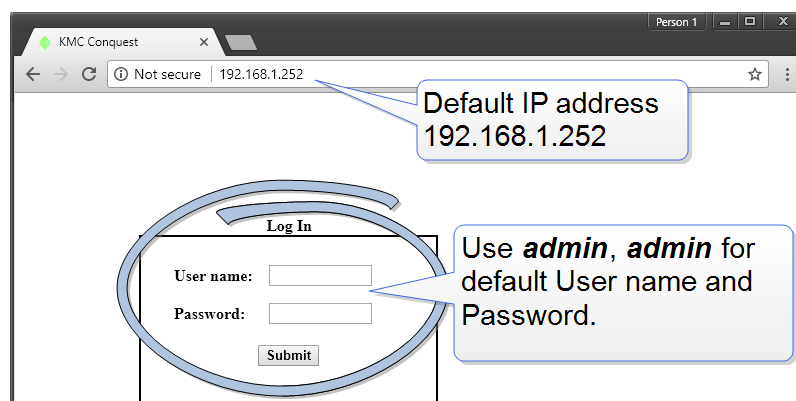

- 5 At the log in window enter the following user name and password.
  - User name: **admin**
  - Password: **admin**

- 6 Once you have logged in, other parameters of the router can be changed from the Home page.
- To change the IP address, see the topic [Device properties on page 21](#).
  - To change passwords and add users, see the topic [Security on page 23](#).



**Note:** Once you change the IP address, place the router on the new subnet and log in using the new address. After the address is changed and saved, the router will not respond to the old address.

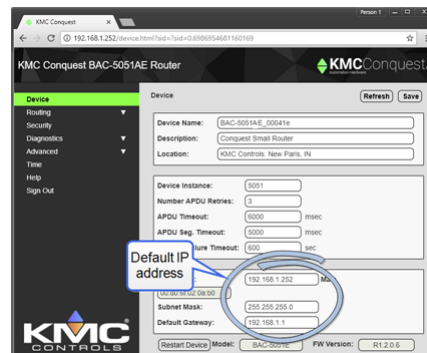

## Changing your computer's address

To directly connect a computer to a router, you must set the IP address of the computer to be compatible with the IP address of the router.

- 1 From the Windows Control Panel, click **Network and Internet** and then **Networking Sharing Center**.
- 2 Choose the local connection for the LAN. Depending on the computer and version of Windows, the exact name for the connection may be *Ethernet*, *Local Area Connection*, or something similar.

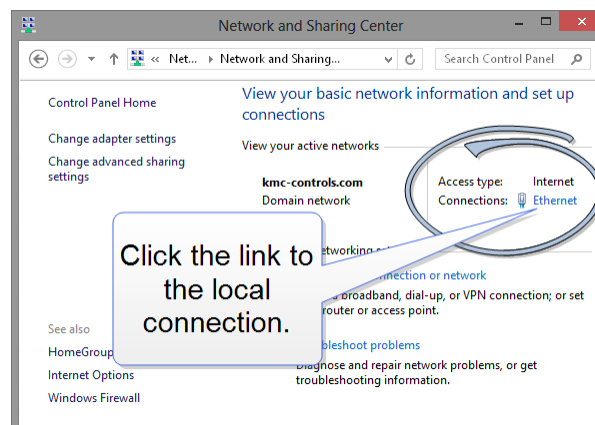

**3** In the Ethernet Status dialog, click **Properties**.

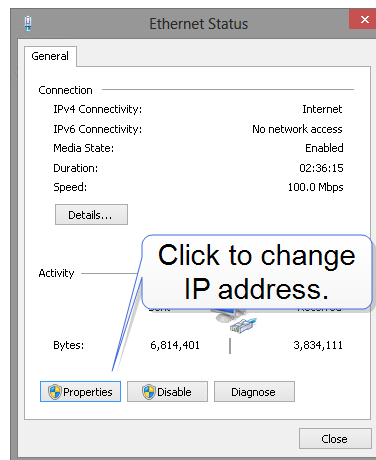

**4** In the Ethernet Properties dialog, scroll and select **Internet Protocol Version 4 (TCP/IP)** and then click **Properties**.

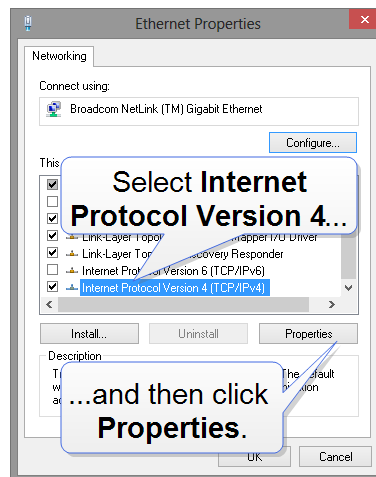

**5** In the Properties dialog, select **Use the following IP address** and then enter the following for the IP address, subnet mask, and Gateway.

- IP address—192.168.1.10
- Subnet mask—255.255.255.0
- Gateway—Leave empty or unchanged

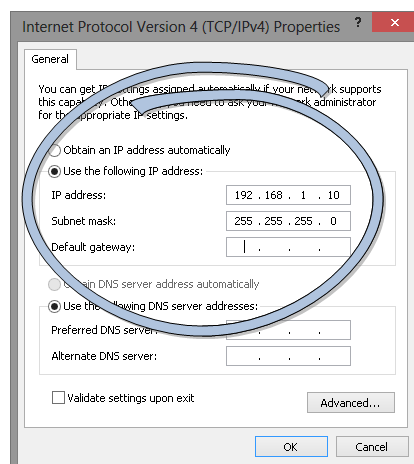

- 6 When all information is correct, click **OK**.

## Device properties

The Device page identifies the BAC-5051AE router for the Local Area Network (LAN). The IP Address, Subnet Mask, and Default Gateway values are supplied by the IT department system administrator.

The Device page also identifies the router as a BACnet device and sets BACnet communication properties. The default device instance for the router is .



**Note:** Once the window is saved, the router will use the new settings and will require you to log in at the new address. If the router is not on the same subnetwork as the network gateway router, it will not function correctly.

**Device Name** The name must be unique among all devices on the BACnet internetwork.

**Description** Optional information not included in the device name.

**Location** An optional value that describes the router's physical location.

**Device Instance** A number that identifies the router on the internetwork. The device instance must be unique on the internetwork and within the range of 0 to 4,194,302. The device instance is assigned by the BACnet system designer. The default device instance is 5051.

**Number APDU Retries** Indicates the maximum number of retries that an Application Layer Protocol Data Unit (APDU) packet is retransmitted.

**APDU Timeout** Indicates the time—in milliseconds—between retransmissions of an APDU packet requiring an acknowledgment for which no acknowledgment has been received.

**APDU Seg. Timeout** The Segment Timeout property indicates the time—in milliseconds—between the retransmission of an APDU segment.

**Backup Failure Timeout** The time—in seconds—that the router must wait before ending a BACnet backup or restore procedure.

**IP Address** The internal or private network address of the router.

**Subnet Mask** Mask determines which part of the IP address is used for a network identifier and which part is used for a device identifier. The mask must match the mask for the network gateway router and other devices on the subnet.

**Default Gateway** The address of the network gateway router. The BAC-5051AE router and gateway router must be part of the same LAN subnet.

**Restart Device** Restarts the router. Similar to restarting the router with a BACnet cold start from KMC Connect or TotalControl. A restart does not change properties or save changes not yet saved.

**MAC** The MAC (Media Access Control) address uniquely identifies the router on the local area network. This number is assigned by the manufacturer and cannot be changed.

## Time

Set the properties of the Time page to set up the router as a BACnet time master device.

**Time** The local time and date as maintained by the router is displayed at the top of the web page. Time and date can be entered directly or synchronized to the time in the computer running the browser.

**Sync to PC** Click to immediately transfer to the router the time and date maintained by the computer running the browser.

**Refresh** Clicking **Refresh** discards any changes and reloads router properties on the web page.

**Save** When finished making changes, click **Save** to make the changes permanent.

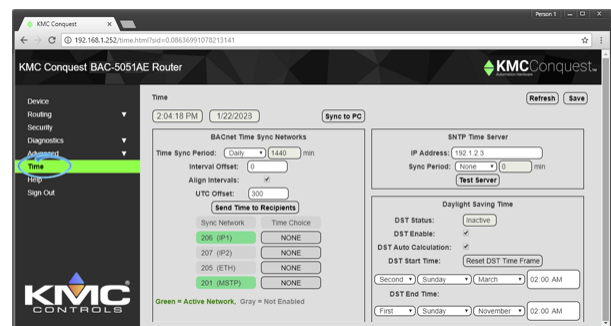

## BACnet Time Sync Networks

Selects the interval and type of BACnet time message for each network.

**Time Sync Period** Sets the interval to send time synchronization to the selected BACnet networks. The choices are None, Daily, Weekly, Monthly, or Custom. The Custom interval is entered in minutes.

**Interval Offset** If Align Intervals is selected, the time synchronization messages are offset, in minutes, from the beginning of the hour or day.

**Align Intervals** If selected and a Time Sync Period is specified, time synchronization messages are sent at the start of the hour or day.

**UTC Offset** The UTC Offset property indicates the time offset—in minutes—between local standard time and Universal Time Coordinated. The value of the property ranges from -780 to +780 minutes. The time zones to the west of the zero degree meridian are positive values; those to the east are negative values. The value of the UTC Offset property is derived from the UTC received in a UTC Time Synchronization service request to calculate the correct local standard time.

**Sync Network** Enabled networks are indicated with a green background. To enable a network,

**Time Choice** Sets the type of time synchronization to NONE, UTC, LOCAL, or UTC & LOCAL. The router supports both UTC and local time synchronization.

- **UTC** The router sends time sync messages in Universal Time Coordinated (UTC). The devices on the network then apply an offset to calculate local time and date. UTC is the preferred method when the building automation system crosses time zones.
- **Local time** The router sends time sync messages in local time from which devices update their internal clock.

## SNTP Time Server

A Simple Network Time Protocol (SNTP) server is a network device that synchronizes the time for devices connected to a local area network. The router receives these time messages and rebroadcasts them as BACnet time service messages.

**IP Address** Enter the address of the SNTP server. The address is supplied by the IT department.

**Sync Period** Select an hourly, daily, weekly, monthly, or a custom interval to send the time synchronization message. The custom period is set in minutes.

**Test Server** Click to test the connection to the network SNTP server.

## Daylight Saving Time

**DST Status** This property indicates *ACTIVE* when Daylight Saving Time is in effect and *INACTIVE* when it is not in effect.

**DST Enable** Enables the router to change its time to Daylight Saving Time. The period of Daylight Saving Time is defined by DST Start Time and DST End.

**DST Auto Calculation** Selecting this check box sets the type of Daylight Saving Time calculation. When selected, the router uses a rules-based calculation for DST figured from the day of the month selected in the DST Start Time and in the DST End Time. When this check box is clear, DST is set to specific calendar dates.

**DST Start Time** Select the ordinal number, day, month and hour that starts Daylight Saving Time.

**DST End Time** Select the ordinal number, day, month and hour that ends Daylight Saving Time.

## Security

- The user name list must include at least one name with Administrator privileges.
- User names and passwords are case sensitive.
- Only the Custom access level can be changed. To do so, select the check box next to each feature to which that role will be granted access. When finished, click **Save\***.

The router is configured with the following default user name and password.

- User name: **admin**
- Password: **admin**

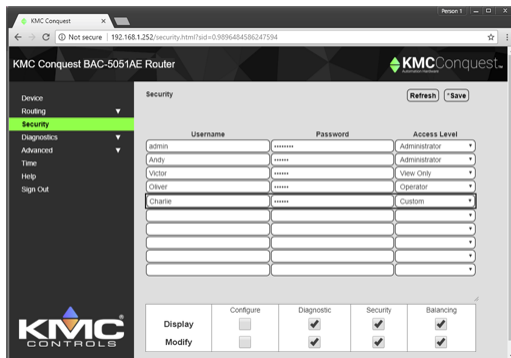

 **Note:** Granting access to the Balancing function also includes access to the Zoning function.

**Table 2–1 Security access levels**

	<b>Configure</b>	<b>Security</b>
Administrator	Display Modify	Display Modify
View Only	Display	
Operator	Display Modify	
Custom	Display* Modify*	Display* Modify*

\*Assigned as required.

## Session timeout

The browser session will automatically close after 60 minutes of inactivity. After 58 minutes, the Reset Session Timer button appears on any open page. Click this button to reset the session timer.





## Section 3:

This section provides important guidelines for configuring a KMC BAC-5051AE router for BACnet routing. Review this information carefully for proper installation. Choices for router configuration must be made to support the system plans for the designed BACnet internetwork.

The BAC-5051AE supports the following routing protocols.

- One MS/TP network
- One BACnet Ethernet
- Two IP networks that can be set up for any of the following protocols:
  - Normal BACnet IP network routing
  - BACnet broadcast management device with network and port address translation
  - Foreign device registration with BACnet broadcast management devices (BBMD)
  - PAD (packet assembly/disassembly) routing

Setting up routing can be performed either during initial configuration or after the router has an IP address assigned and is installed in its permanent location. See [Configuring the BAC-5051AE router on page 17](#) for initial configuration and log in procedures.

### Topics in this section

BACnet IP routing .....	25
BACnet Foreign device routing .....	26
BACnet Broadcast Management Device routing .....	27
PAD routing .....	29
BACnet Ethernet routing .....	30
MS/TP configuration .....	30
Router Core properties .....	31

## BACnet IP routing

Either of the two IP ports can be configured for normal IP routing. The values to be used on this page are assigned by the BACnet system engineer.

For the log in procedure, see the topic [Initial setup on page 17](#).

- 1 Use an Internet browser to log in.
- 2 Click **Routing** .
- 3 Click **Configuration**.
- 4 Select **Enable** for one of the IP Ports.
- 5 Click **\*Save**.
- 6 Select **Enable** for the IP Port.

- 7 From the list box, choose **IP (Normal)**.
- 8 Click **\*Save**.
- 9 Set the Network and Port properties as needed, clicking **\*Save** after making each change.

**Note:** Changes may not implement correctly if more than one at a time is made.

**Note:** The router will restart when a change is made and saved. To make additional changes, log in again.

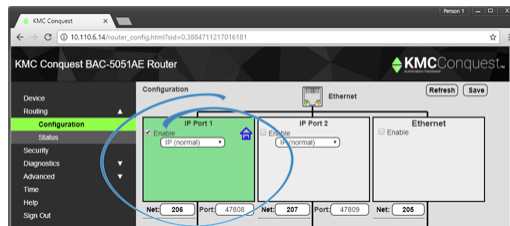

**Enable** Select to enable the network. The port block turns green when enabled.

**Port** Assign a unique UDP port number to each of the enabled IP networks. The default port number is 47808.

**Net** Designates the BACnet network number for the port. Assign network numbers in the range from 1 to 65534.

### *Other IP routing protocols*

## BACnet Foreign device routing

A BACnet Foreign Device configuration can be useful for temporary network connections such as when using the router as a technician's diagnostic tool. For long-term network connections, KMC Controls recommends setting up a BACnet Broadcast Management Device (BBMD) configuration. Refer to [BACnet Broadcast Management Device routing](#).

Either of the two IP ports can be configured as a BACnet Foreign device. The values on this page are assigned by the BACnet system engineer.

For the log in procedure, see the topic [Initial setup on page 17](#).

- 1 Use an Internet browser to log in.
- 2 Click **Routing**.
- 3 Click **Configuration**.
- 4 Select **Enable** for the port.

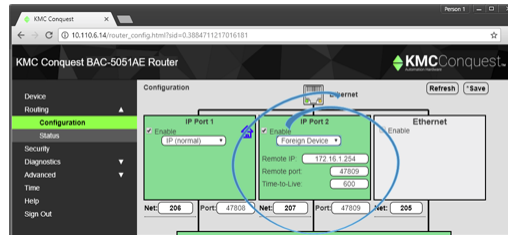

**Enable** Select to enable the network. The port block turns green when enabled.

**Net** Designates the BACnet network number for the port. Assign network numbers in the range from 1 to 65534.

**Port** Assign a unique UDP port number to each of the enabled IP networks. The default port number is 47808.

**Remote IP** Enter the address of the remote BBMD. If network address translation (NAT) is used between the BAC-5051AE router and the BBMD, contact the network system administrator for the correct public IP address.

**Remote Port** Enter the port number of the remote BBMD. If port address translation (PAT) is used between the BAC-5051AE router and the BBMD, contact the network system administrator for the correct public UDP port.

**Time To Live** Sets the interval at which the router sends a registration message to the BBMD with which it is registered. The valid range is 1 to 65535 seconds.

## BACnet Broadcast Management Device routing

For long-term network connections, KMC Controls recommends setting up a BACnet Broadcast Management Device (BBMD) configuration.

Either of the two IP ports can be configured as a BBMD. When configuring an IP port as a BBMD, keep in mind the following rules.

- Configure only one BBMD for a single IP subnetwork.
- Assign the same BACnet network number to all BBMDs on the internetwork.
- The BBMD can accept registration from BACnet foreign devices or perform BBMD-to-BBMD routing.

For more information about BBMDs, refer to the application guide [All About BACnet Broadcast Management Devices \(BBMD\)](#).

For the log-in procedure, see the topic [Initial setup on page 17](#).

To set up the router as a BBMD, do the following:

- 1 Use an Internet browser to log in.
- 2 Click **Routing**.
- 3 Click **Configuration**.
- 4 For the port, select **Enable**.
- 5 From the IP Port list box, choose **BBMD**.

**6 Click Table.****7 Type entries in the Broadcast Distribution Table (BDT).**

Max. FD Table Entries:	<input type="text" value="128"/>	<input type="button" value="Close"/>	
<input type="checkbox"/> Enable FD Service			
<input type="checkbox"/> Accept Remote Configuration	<input type="button" value="Add"/>	<input type="button" value="Remove"/>	
<b>sel</b>	<b>IP Address</b>	<b>Subnet Mask</b>	<b>Port</b>
<input type="checkbox"/>	192.168.1.252	255.255.255.255	47809

**8 Set other properties as needed and then click \*Save.**

**Note:** The router will restart. To make additional changes, log in again.

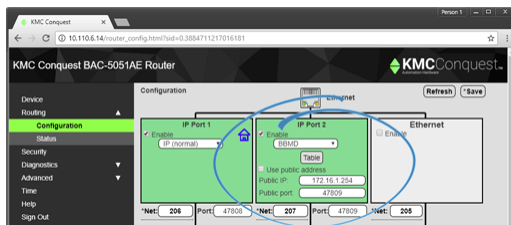

**Enable** Select to enable the network. The port block turns green when enabled.

**Net** Designates the BACnet network number for the port. Assign network numbers in the range from 1 to 65534.

**Port** Assign a unique UDP port number to each of the enabled IP networks. The default port number is 47808.

## Network address translation

When using Network address translation, coordinate with the IT department to obtain a public IP address and a port exception in the firewall.

**Use public address** Select to enable network address translation and port forwarding.

**Public address** The static public IP address supplied by the IT department.

**Public port** The public UDP port supplied by the IT department. For security, use a port that is not in the typical range of BACnet ports.

## Table

The items in Table define the Broadcast Distribution Table (BDT) for the BBMD. Enter the IP address, UDP port number and IP subnet mask of each BBMD that is part of the internetwork.

- If no BBMD uses a public IP address, then the BDT entries in every BBMD are the same.
- If the BBMD uses a public IP address, then the BDTs are different in every router. Each BDT will use its own private IP address, port number and subnetwork mask and the public IP address, port number and subnetwork mask for all of the other BBMDs on the internetwork.

To add or delete entries, do the following:

- Adding entries—Click **Add** and type entries as needed. When finished, click **\*Save**.
- Deleting entries—Select **sel** and then click **Remove**.

**Max FDT Table Entries** Sets the maximum number of foreign devices that can register at one time. The range of values for MAX FDT Entries is 1 to 128.

**Enable FD Service** When selected, the BBMD permits foreign devices to register with the BBMD. The maximum number of devices is limited by the value in Max FDT Table Entries.

**Accept Remote Configuration** When selected, the BBMD will update the BDT with a table it receives from another BBMD.

## PAD routing

Either of the two IP ports can be configured for PAD (packet assembler/dissassembler) routing to a companion PAD router located on a different subnetwork. The values on this page are assigned by the BACnet system engineer.

For the log in procedure, see the topic [Initial setup on page 17](#).

- 1 Use an Internet browser to log in.
- 2 Click **Routing** and then **Configuration**.
- 3 Select **Enable** for the port.
- 4 From the list box, choose **PAD**.
- 5 Set other properties as needed and then click **\*Save**.

**Note:** The router will restart. To make additional changes, log in again.

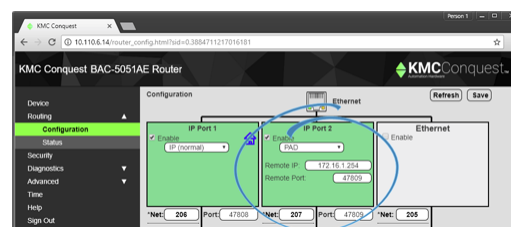

A BACnet IP PAD router is a special type of router that connects two or more BACnet network segments that are separated by at least one IP-only router. The PAD router monitors network traffic for BACnet messages addressed to other subnetworks and then repackages the message so that it can pass through IP routers. In effect, this forms a “tunnel” between the two network segments. A companion PAD router unpacks and retransmits the message on the remote BACnet network.

**Enable** Select to enable the network. The port block turns green when enabled.

**Net** Designates the BACnet network number for the port. Assign network numbers in the range from 1 to 65534.

**Port** Assign a unique UDP port number to each of the enabled IP networks. The default port number is 47808.

**Remote IP** Enter the address of the remote PAD router. If network address translation (NAT) is used between the local router and the PAD router, contact the network system administrator for the correct public IP address.

**Remote Port** Enter the port number of the remote PAD router. If port address translation (PAT) is used between the BAC-5051AE router and the PAD or BBMD, contact the network system administrator for the correct public IP address.

#### *Other IP routing protocols*

- [BACnet Broadcast Management Device routing on page 27](#)
- [BACnet IP routing on page 25](#)
- [BACnet Foreign device routing on page 26](#)
- [Router Core properties on page 31](#)

## BACnet Ethernet routing

Configure the Ethernet port in this page. The values on this page are assigned by the BACnet system engineer.

**Enable** Select to enable the network. The port block turns green when enabled.

**Net** Designates the BACnet network number for the port. Assign network numbers in the range from 1 to 65534.

## MS/TP configuration

Configure the MS/TP network in this page. The values on this page are assigned by the BACnet system engineer.

For the log in procedure, see the topic [Initial setup on page 17](#).

- 1 Use an Internet browser to log in.
- 2 Click **Routing**.
- 3 Click **Configuration**.
- 4 Select **Enable** for the MS/TP port.
- 5 Enter the Network number and a MAC address for the router.

6 Set Baud Rate. All devices on the MS/TP network must use the same Baud.

7 When finished, click \*Save.

**Note:** The router will restart. To make additional changes, log in again.

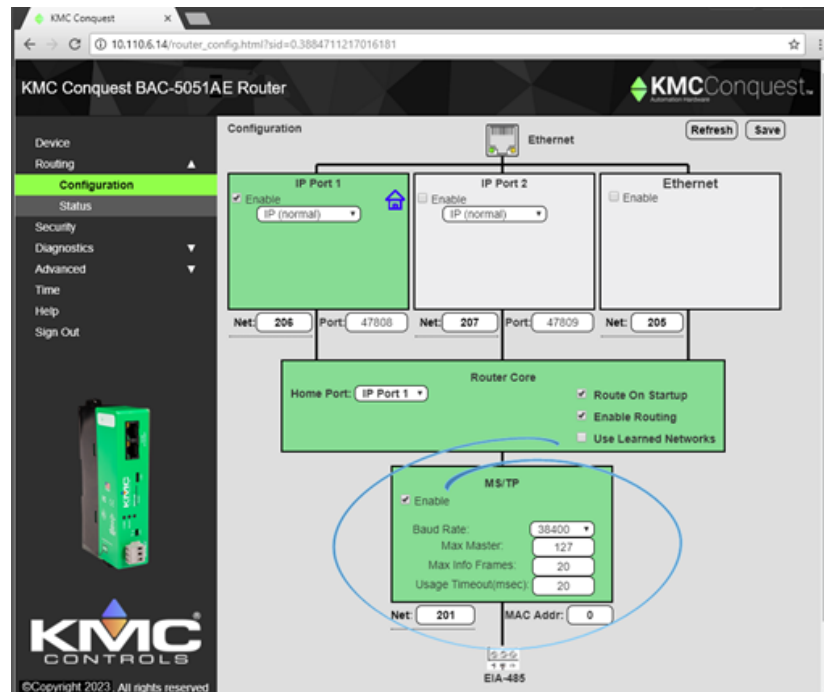

**Enable Select** to enable the network. The port block turns green when enabled.

**Net** Designates the BACnet network number for the MS/TP port. Assign a network number that is in the range from 1 to 65534.

**Baud Rate** Select the baud rate from the drop-down list. The baud rate for the router and all devices connected to the MS/TP network must be the same.

**Max Master** Set to 127 or no lower than the highest MAC address on the network. See [Device Status on page 40](#).

**Usage Timeout** Sets the maximum time the router will wait on a response from a master device before passing the token.

**MAC Address** The MAC (Media Access Control) address assigned to the router for the MS/TP network. This must be unique on the MS/TP network and in the range from 0 to 127. Typically, the MAC address for a router is zero (0).

## Router Core properties

The Router Core properties are general properties that apply to all routing protocols. The properties consist of the Home Port selection and the Routing properties.

## Home port

Because the router is a BACnet device, it must be connected to one of the BACnet networks by setting the Home Port property. The home port:

- is designated on a router port by the Home Port icon .
- sets the network on which the router is connected. In operator workstations, the router appears on the network designated as the home port network.
- can be assigned to an enabled network only.



**Caution:** Using the MS/TP network reduces the APDU size and significantly increases network traffic. KMC Controls recommends that one of the IP ports or the Ethernet port is designated as the home port.

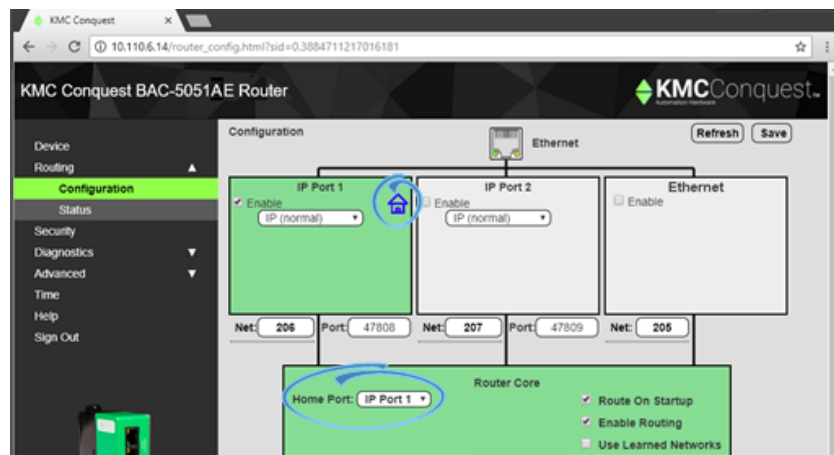

## Routing properties

**Route On Startup** When selected, the router will immediately begin routing after a power cycle or BACnet cold start. This includes restarting the router on the [Device properties on page 21](#). The router will also select the Enable Routing check box during the reset or power up procedure.

**Enable Routing** When this check box is cleared, routing on all ports is disabled, but the router remains an active device on the BACnet Internetwork. The MS/TP diagnostic and Routing Status pages are still active. When routing is not enabled, the background of the Router Core box is gray. When routing is enabled, the background is green. Routing can also be enabled or disabled on the [Routing Status on page 35](#).



**Use Learned Networks** When selected, the router will attempt to learn the network number that is being using on a port. This works only in the event that there is at least one other router on the network that responds to a BACnet *What-Is-My-Network-Number* request. If available, the router will use the learned network. Otherwise, the router will use the configured network number.

### Illustration 3–1 Routing properties

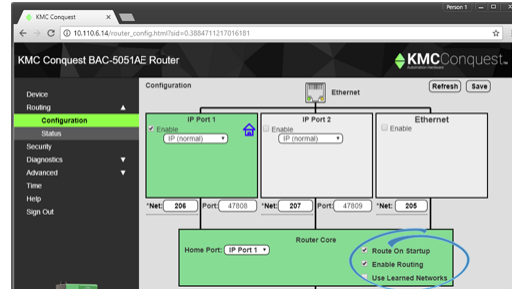



## Section 4: Status and diagnostics

Topics in this section cover status and router diagnostic functions.

---

The BAC-5051AE router includes several status and function pages for diagnosing problems and improving the efficiency of the connected networks.

- The topic [Routing Status](#) applies to all connected networks.
- The topics [Device Status](#), [MS/TP Metrics](#), and [Token Use](#) apply to the MS/TP network.

### Topics in this section

Routing Status .....	35
Device Status .....	40
Token Use .....	42
MS/TP Metrics .....	43
MS/TP Capture .....	46

## Routing Status

The BAC-5051AE router includes BACnet routing functions. References to the router and routing in this topic refer to the BACnet routing functions and networks, including the BACnet virtual network, within the router. The status of the KMDigital networks, controllers, or points are not included on this page.

The Routing Status page contains a network status list and command buttons to update the display and networks. The page consists of three major parts.

- Send commands to the router with the [Routing Status buttons on page 36](#).
- View the status of networks in the [Route Status list on page 37](#).
- Clear selected networks by [Purging the Route Status list on page 39](#).

**Enable Routing** When this check box is clear, routing on all ports is disabled but the router remains an active device on the BACnet internetwork. The MS/TP diagnostic and Routing Status pages are still active. Routing can also be enabled or disabled on the [Router Core properties on page 31](#).



**Note:** Enable Routing will not remain selected after a restart if Route On Startup is not selected on the [Router Core properties on page 31](#).

**Refresh** Click to refresh the Route Status list. To automatically refresh the list every 10 seconds, select the **Auto Refresh** check box.

**Routing Status** Enable Routing  Auto Refresh  Refresh

Send I-Am-Router-To-Network    Clear Direct Network Status    Purge Remote Networks

Send Who-Is-Router-to-Network    Clear Remote Network Status    Send Sequence (Purge, Clear I-Am-Router-To-Network)

Legend	Status	Net		Next Router		Time	Idle Time	
		Destination	Discovered	Net	Addr			
Ⓜ	Sole Master	2500	N/A	Directly Connected	Not Applicable	00:02:12	00:00:00	Select Routes
●	Active	11891	N/A	Directly Connected	Not Applicable	00:02:15	00:00:02	Select Routes
●	Active	205	N/A	11891	10.110.2.204.47801	00:02:15	00:01:33	Select
●	Active	1104	N/A	11891	10.110.2.204.47801	00:01:33	00:01:33	Select
●	Active	1106	N/A	11891	10.110.2.206.47801	00:01:33	00:01:33	Select
●	Active	1107	N/A	11891	10.110.2.207.47801	00:01:33	00:01:33	Select
●	Active	2000	N/A	11891	10.110.6.13.47801	00:02:02	00:01:33	Select
●	Active	3000	N/A	11891	10.110.6.12.47801	00:02:09	00:01:33	Select
●	Active	18895	N/A	11891	10.110.6.13.47801	00:01:33	00:01:33	Select

# of Networks Displayed  (Actual ) Purge

## Routing Status buttons

The Route Status buttons are useful for diagnosing routing and network problems.

**Send I-Am-Router-To-Network** Broadcasts to all networks that the router is connected to the network. This can trigger updates throughout the network.

**Clear Direct Network Status** Forces the status of all direct networks to Active. If a network problem continues after clearing the direct networks, the networks with problems will return to a status other than Active.

**Purge Remote Networks** Removes all remote routes from the network table.

**Send Who-Is-Router-to-Network** Initiates a query to other routers that results in the discovery of other networks. Other routers respond with a BACnet I-Am-Router-To-Network message.

**Clear Remote Networks** Forces the status of all remote networks to Active. If a problem continues with a remote network, it will return to a status other than Active.

**Send Sequence** Sequentially broadcasts the three commands Purge, Clear and Send I-Am-Router-To-Network.

## Route Status list

The Routing Status list is a diagnostic display of all networks known to the router. Both direct and remote networks are listed.

- Direct (or local) networks are connected directly to the router.
- Remote networks are on the other side of one or more remote routers. The path to a remote network always includes at least one directly connected network.

Each of the columns lists information about local or remote networks.



**Tip:** If a directly connected network is shown to have a problem, the remote networks that connect to it will also show problems. Correct directly connected network problems before troubleshooting remote network problems.

**Status** The status of each network known to the router. See the table [Route status conditions \(continued\)](#) for a description of each condition.

**Net** The columns under Net will change modes depending on the setting of Use Learned Networks on the [Routing Status on page 35](#).

**Destination** The Destination is always the network number the router is using.

- If Use Learned Networks is enabled, this is the learned network number.
- If Use Learned Networks is not enabled, this is the network number entered for the port on the Configuration page.

**Configured** (Use Learned Networks enabled) The network number that is configured for the port on the Configuration page. If this number is different than the Destination network, the network number displays in red.

**Discovered** (Use Learned Networks not enabled) The learned network number at a port. If this network number is different than the network number on the Configuration page the number is in red and the status will be other than Active. Other networks are listed as N/A.

**Next Router** A list of each network connected to the router's ports that will be used to route a message to the next router.

- **Network** The BACnet network number to the next router.
- **Address** The MAC address of the next router.

**Time** The time elapsed since the status update.

**Idle Time** The time elapsed since the router last passed traffic to the network.

**Table 4–1 Route status conditions**











Status	Icon	Description	Action
Active		The network is functioning correctly and is capable of passing traffic.	None required.
Busy		The amount of network traffic is high enough that no new traffic can be accepted.	A temporary condition that does not require intervention.
Down Gone		The network is not functional and is rejecting traffic.	Most likely will require manual intervention. Conditions that cause a network to be down may include either LAN or BACnet router problems.
No Status		The router is searching for the network.	Usually a temporary condition. Does not require intervention.
Duplicated Network		Two networks are using the same network number. A router cannot pass traffic on a duplicated network.	Usually requires intervention to locate and change the duplicated network number. Multiple duplicated networks are usually an indication of a network loop.
Duplicate MAC		The router has detected two MS/TP device using the same MAC address. Traffic is not routed.	Change the MST/TP MAC address in either the router or the device that contains the duplicated number.
Sole Master		The router is not detecting any master MS/TP devices on the local network.	Requires corrective action if master devices are known to be connected to the local MS/TP network.

Table 4–1 Route status conditions (continued)

Status	Icon	Description	Action
BBMD: Unknown		Indicates the router is receiving BBMD traffic from an unknown BBMD. This does not stop traffic from routing.	If appropriate, add the unknown BBMD to the local BDT. A possible cause of unknown traffic is an address issue because of network address translation.
BBMD: Multiple		Indicates the router has detected another BBMD in the same subnet as itself. Traffic is not routed.	Remove a BBMD from the network.
Foreign Device NAK		A foreign device is preventing the router's request to distribute messages. Initially, this will not block traffic. However, as additional registration requests are received, attempts speed up until traffic is stopped.	The remote device server cannot register additional devices. Increase the value of Max FDT Entries in the remote server or register with a different server.
Mismatched Network Number		The learned network does not match the configured network.	Select <b>Use Learned Networks</b> on the Configuration page or change the router's network number.

## Purging the Route Status list

To clear old data from the Route list, select a network and then click **Purge**.

- Choose **Select** to remove a specific remote network from the table.
- Choose **Select Routes** to remove all of the remote routes related to a directly connected network.

The selected network or networks are then cleared from the list. As the router detects the actual networks in use, they are added back to the list.

## Device Status

The Device Status page is a color-coded status display and a list of metrics for the MS/TP network. The background color of each MAC address indicates its status.



**Note:** When the Diagnostics page opens, the router shows active network devices in green. After clicking Refresh, any device that was active but has stopped communicating within the last few seconds changes from green to gray.

See the topic [on page 25](#)

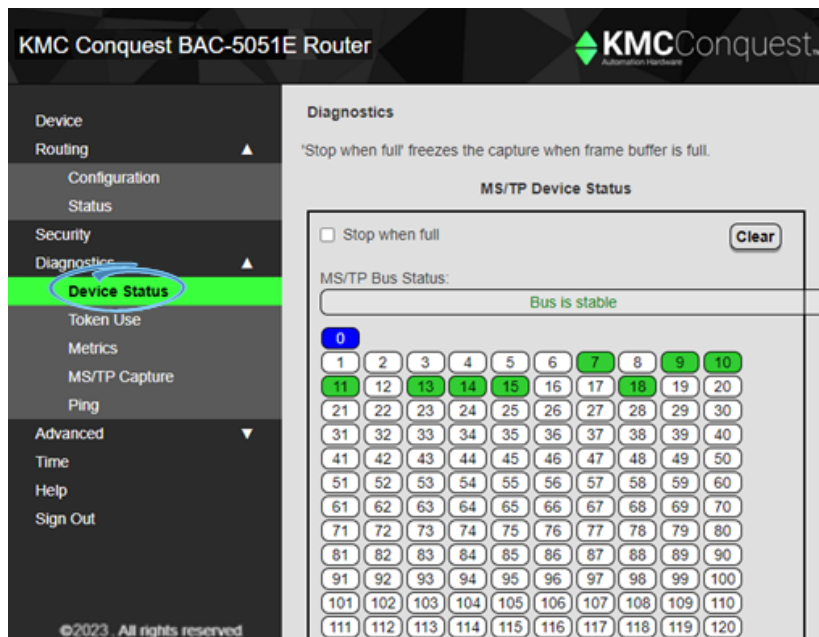





### Operation

**Stop when full** When selected, freezes the capture when the frame buffer is full.

**Clear** When selected, deletes all current color indications in the MS/TP Device Status display and values in the metrics list and updates the window with the latest network status and metrics.

**Table 4–2 Device status**

Color	Icon	Description
White		No device is assigned to this MAC address.
Gray		A device was active with this MAC address but is no longer online.
Blue		The MAC address assigned to the router.
Green		The MAC address is assigned to an active device.
Red		Two devices are using the same MAC address.



If you encounter difficulty, click **Refresh** about every 10 seconds to observe how the Device Status changes.

- If a MAC is red, start disconnecting devices from the network and click **Refresh** as you disconnect until the red goes away. This will help find the device that has the same MAC address as the router.
- Gaps in the MAC addresses. MAC address gaps make the network less efficient because devices will continually search for devices in the gap. Small gaps between the router and the first device are acceptable, but try to eliminate gaps between devices by changing MAC addresses.
- Gray can indicate several issues. This means communications at or near the gray MAC address is intermittent. This can be caused by noise, loose wiring, and duplicate MAC addresses. It could mean the end-of-line termination is not set properly. It could mean a device has bad power and is resetting often. The problem is usually associated with the first device that is shown gray.
- Known devices are not green. This is usually caused by bad wiring, bad grounding, or not having the same baud-rate for the router and devices. To isolate the problem, start splitting the network by physically disconnecting wires until devices begin communicating.

Network metrics are useful for evaluating overall network performance.

#### Network metrics

Metric	Description
Total Devices	The number of devices on the network including the router
AVG Token Cycle time	The time for the token pass to all controllers and return
AVG Token Time per device	Typically 10 ms or less
Last Master MAC Address	The highest MAC address found by the router.

## Token Use

The Token Use page is a dynamic display of token passing on the network. The colors of each device indicate the speed of token passing.

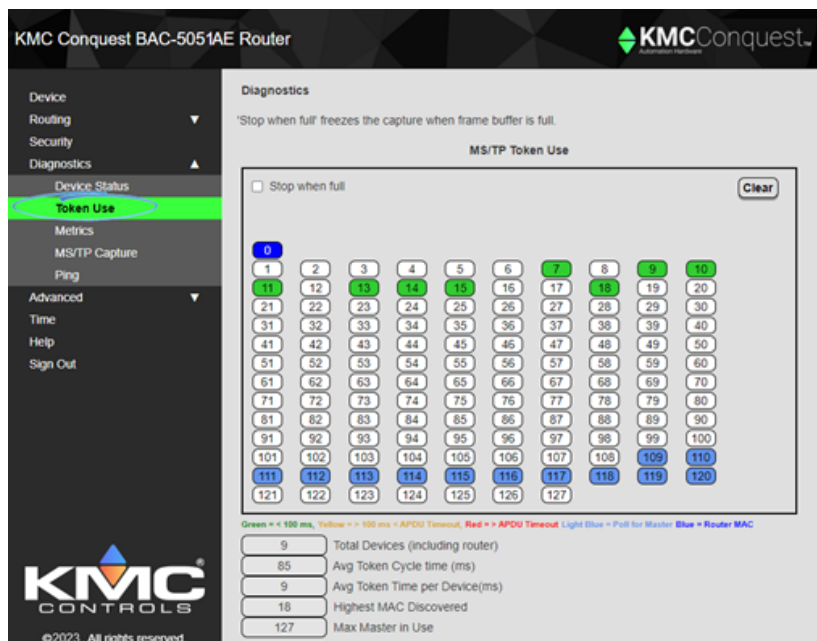

### Token use by color

Color	Description	Condition	Action
Blue	The MAC address assigned to the router.	Light traffic. Will change to green or yellow if traffic increases.	None required.
Green	Token passed in less than 100 ms.	Normal token passing.	None required.
Yellow	Token passed is more than 100 ms but less than the value of APDU Timeout.	Token passing is slow, but the device is still functional.	Indicates a potential bottleneck. No action is needed if the device returns to green.
Red	APDU Timeout	The device is retaining the token too long.	A bottleneck in network traffic. A typical cause is excessive or continuous polling for data in other controllers.
Light Blue	Poll for Master	A device is polling for a master device.	This is normal if there are gaps in the MAC addresses.

### Operation

**Stop when full** When selected, Stop when full freezes the capture when the frame buffer is full.

**Clear** Removes data from the window and refreshes it with the current network status.

Network metrics are useful for evaluating overall network performance.

**Network metrics**

Metric	Description
Total Devices	The number of devices on the network including the router
AVG Token Cycle time	The time for the token pass to all controllers and return
AVG Token Time per device	Typically 10 ms or less
Last Master MAC Address	The highest MAC address found by the router.

**MS/TP Metrics**

Network metrics are useful for evaluating network performance and troubleshooting MS/TP network problems.

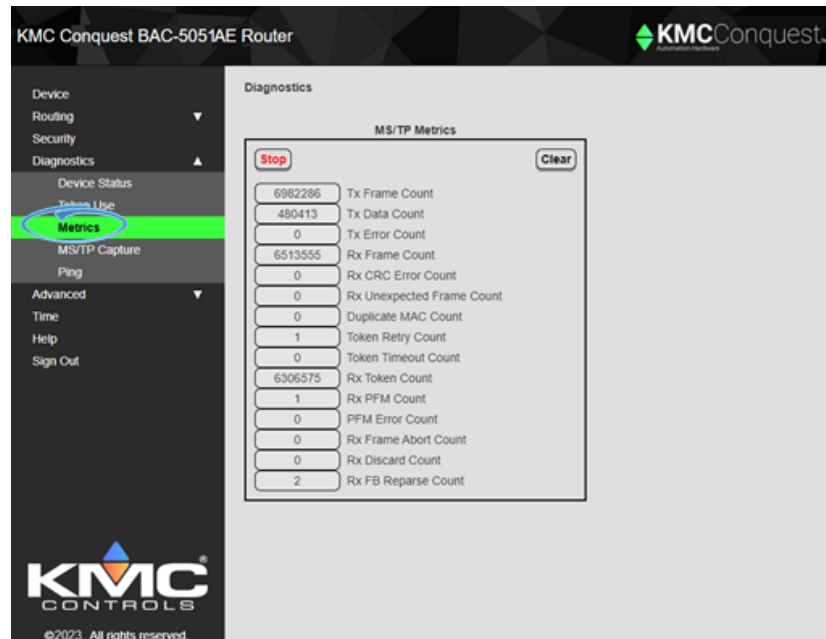

**Operation**

**Stop** When clicked, freezes the current values in the window. Clicking **Start** begins data collection again.

**Clear** Removes data from the window.

**Interpreting the diagnostic data**

Even the best designed and installed network will have minor or infrequent communications issues. The following tips will help determine the significance of the network metric as well as suggestions for improvement.

**Tx and Rx Frame Counts** The actual number of frame counts depends on the baud rate and number of network devices. The more connected devices, the slower the frame counts

grow. Unless the relative difference between the two counts is greater than 10%, the network is generally in good health. The reason the router sends more messages than it receives is primarily because of the small gap between its own MAC address and the next device.

**Rx Frame Count greater than Tx Frame Count** The greater the difference, the higher the probability of the following conditions.

- One or more devices somewhere in BACnet internetwork is sending a lot of broadcast messages.
- One or more devices on the router's MS/TP network is sending a lot of network unicast messages.

The usual cause is a device trying to find other devices that do not exist or are not communicating properly and are repeatedly sending BACnet WHO-IS messages. It is typical for this to be caused by a Control Basic program or a Notification Class object recipient list referring to a device that does not exist.

**Rx Frame Count much less than Tx Count** This may be accompanied by a device showing a gray, offline status. It usually means devices are not communicating reliably either because of noise or because they are inundated with network messages and cannot keep up.

**Tx Data Count** This is the number of messages that contain actual point data. Most other messages are just passing the token. In the previous example, the Data Count is only 0.1% of the Tx Frame Count. This means the network is passing a small number of points or trends. If this ratio is more than 30%, it may indicate a problem because it is likely that one or more devices or workstations are gathering more data than is really needed. This can mean the network will drop important messages.

**Token Retry or Token Timeout** This usually indicates a problem with the device next to the router in the MAC chain. The cause could be noise specific to the device or general network noise. This is not a problem unless there are more than 10 counts in a 24-hour period.

**Rx PFM Count** This indicates a problem between the router and the device just before it in the MAC chain, usually the one at the end. A few counts in a 24-hour period is not unusual.

**All other metrics** Other metrics typically do not indicate a problem unless a value exceeds 10 counts in a 24-hour period.

## Description of the Metrics page

The following table describes each of the properties displayed on the MS/TP Metrics page.

**Table 4–3 Diagnostic metrics**

<b>Metric</b>	<b>Description</b>
Tx Frame Count	The number of transmissions sent by the router.
Tx Data Count	The number of transmissions sent by the router that included data.
Tx Error Count	The number of transmissions sent by the router that were in error.
Rx Frame Count	The number of frames received by the router.
Rx CRC Error Count	The number of frames intended for the route with a bad Cyclic Redundancy Check (CRC).
Rx Unexpected Frame Count	The number of frames with an unexpected error that were received by the router.
Duplicate MAC Count	The number of times the router received a message from another device with the same MAC.
Token Retry Count	The number of times the router had to retry passing the token.
Token Timeout Count	The number of times the token passing from the router to the next device failed.
Rx Token Count	The number of times the router received the token.
Rx PFM Count	The number of times the router received a poll-for-master message for its own MAC.
PFM Error Count	The number of times the router was expecting a poll-for-master message and did not receive it.
Rx Frame Abort Count	The number of frames that were terminated because of a timeout error.
Rx Discard Count	The number of frames rejected because of mismatched timing or preambles.
Rx FB Reparse Count	The number of times more than one frame was found inside of the frame buffer.

## MS/TP Capture

Use the MS/TP Capture page to monitor and save the BACnet traffic on the MS/TP network. The captured traffic can then be saved in a standard `.pcap` (Packet CAPture) file format. Once the data is saved, it can be analyzed with Wireshark or any other network analysis program that uses `.pcap` files.

To use the MS/TP Capture feature, the router must be connected directly to the monitored MS/TP network. This can be from either an existing router or a router temporarily connected as a service tool.

Illustration 4–1 MS/TP Capture page

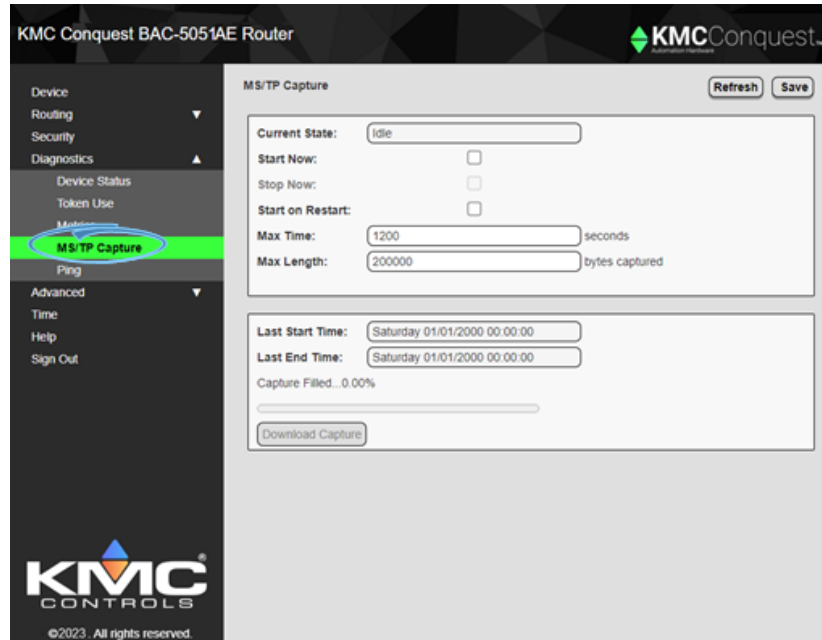

**Current State** Shows the status of the capture. The status can be any of the following conditions.

- Idle
- Starting Capture
- Capturing
- Ending Capture
- Data Ready
- Error

**Start Now** Select this check box and then click **Save** to start a capture. The capture will continue until the length of time set in Max Time, the amount of data set in Max Length, or the maximum buffer size is reached.

**Stop Now** Select this check box and then click **Save** to end a capture. The data can then be saved by clicking **Download Capture**.

**Start on Restart** Select this check box and then click **Save**. The router will restart and capture MS/TP traffic until the Max Time or Max Length is reached or the buffer is full. The maximum amount of space to store captured data is 1 megabyte. The router will capture MS/TP traffic after every restart until Start on Restart is cleared.

**Max Time** Enter the length of time, in seconds, for a timed capture.

**Max Length** The amount of data, in bytes, to capture.

**Last Start Time** For information only. This is the time—as maintained by the clock in the router—when the last capture started.

**Last End Time** For information only. This is the time—as maintained by the clock in the router—when the last capture ended.

**Capture Filled** The percentage of available buffer space to store a capture. The maximum amount of space to store captured data is 1 megabyte.

**Download Capture** When this link is blue, captured data is ready to save to the computer on which the browser is running. Data is saved in the file format `.pcap` (Packet CAPture). The first capture is saved as `Capture.pcap`. Additional captures are saved with a number appended to the file name (`Capture (1) .pcap`, `Capture (2) .pcap`, etc.). Files are saved in the `Downloads` folder for the current Windows user.





## Section 5: Advanced features

This section covers features for maintaining the router, balancing VAV controllers, and configuring zoning FlexStats.

---

Features in the Advanced group are for updating firmware in the router, backing up the router configuration, balancing VAV controllers, and configuring BAC-120063CW-ZEC zoning FlexStats.

**Recovering the IP address**—Discover an unknown network IP address.

**Firmware updates**—From time to time, KMC Controls issues updates to the firmware for the router. The updates can be added directly to the router from the browser pages.

**Configure from file**—Configuration properties for the router can be saved in a JSON (JavaScript Object Notation) file. The file can then be used as a backup file or to configure other routers with similar properties.

**Balancing**—Commands for balancing the airflow in BAC-8000 or BAC-9000 series controllers.

**Zone configuration**—Commands to set up a BAC-120063CW-ZEC zoning FlexStat.

### Topics in this section

Recovering the network address .....	49
Updating the firmware .....	50
Configure from a file .....	51

## Recovering the network address

If the network address of the router is lost or unknown, the router will respond to the default IP address for the first 20 seconds after power is applied.

- 1 Disconnect the router from the LAN and connect the router as described in the topic [Initial setup on page 17](#).
- 2 Unplug the router from the power source.
- 3 On the computer, open a browser window and enter the default address of 192.168.1.252.
- 4 Reconnect the router from the power source and immediately attempt to connect with the browser. The browser will respond with the router's IP address and subnet mask.

- Once the address is known, connect the router to the correct IP subnet for normal operation or router configuration.

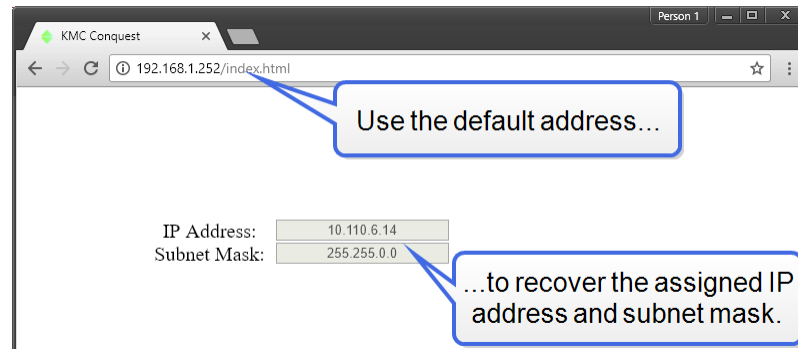

## Updating the firmware

The router firmware can be updated from the Firmware page in the Advanced group.



**Note:** The router firmware can also be updated with KMC Connect, TotalControl, or the Firmware Upgrade Tool. For instructions, see the help and other documentation for those programs.

### Illustration 5–1 Firmware update page



To update the firmware, do the following:

- Download the new firmware from the KMC Partner Portal. A self-extracting executable file will install the firmware in the correct location.
- Run the downloaded file. This will place a .zip file in the folder at `C:\ProgramData\KMC Controls\Firmware Upgrade Manager\BACnet Family\BAC-5051AE`. Do not unzip this file.
- Use an Internet browser to log in to the router.

- 4 From the **Advanced** group, choose **Firmware**.
- 5 Click **Choose File** and browse to the following location: `C:\ProgramData\KMC Controls\Firmware Upgrade Manager\BACnet Family\BAC-5051AE`.
- 6 Locate and open the folder with the correct version of firmware.
- 7 Select the `.zip` file.
- 8 When the Proceed with download? dialog box opens, click **OK**.
- 9 When the download is finished, click **Commit**.
- 10 In the Restart Device? dialog box, click **OK**. The router will restart.

## Configure from a file

Configuration properties for the BAC-5051AE router can be saved in a configuration file. The configuration file can then be used as a backup file or to configure other routers with similar properties.

- 1 Use an Internet browser to log in.
- 2 From the **Advanced** group, click **Choose File**.
- 3 Browse to the file location.
- 4 Choose the file.
- 5 Click **Open**.
- 6 When the Overwrite Router Configuration dialog opens, click **OK** to proceed.

**Choose File** Browse to the location and choose the configuration file.

**Save Configuration** Saves the router configuration in the file `config_5051AE.json`. The file type is JSON (Java Script Object Notation) and it is saved in the current Windows user's Downloads folder.

**Illustration 5–2 Configure from File page**

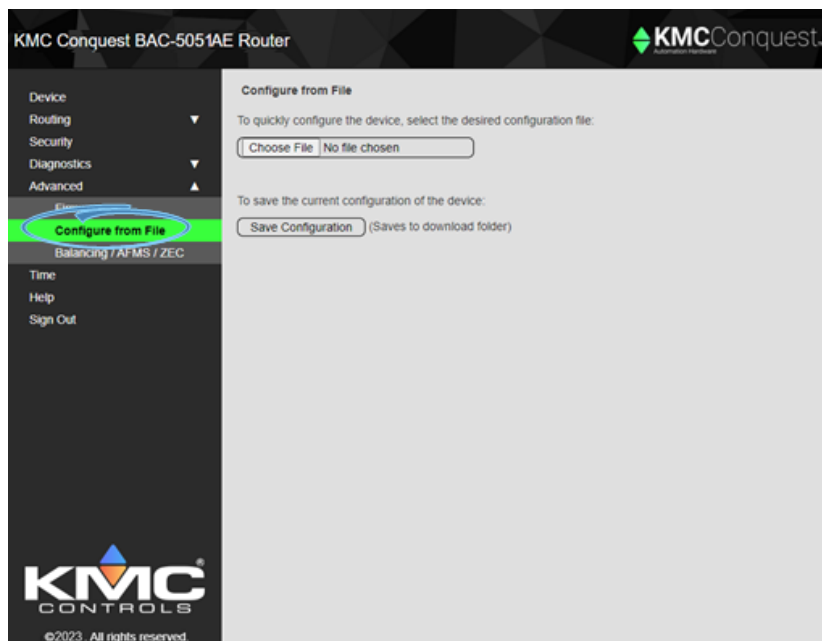

## Index

### 2

24 volt power 11

### A

accessories 7  
address unknown 49  
advanced features 49  
    firmware updates 50

### B

baud 5

### C

capture, MS/tP diagnostics 46  
configuration  
    for network 17  
    home port 31  
contact information 14

### D

default  
    gateway address 17  
    IP address 17  
    subnet mask 17  
diagnostics  
    MS/TP capture 46  
dimensions 7  
DIN rail mounting 8

### E

enable routing 31  
end-of-line switches 9  
environmental limits 7  
Ethernet routing 30

### F

file types  
    PCAP 46  
firewall 9  
firmware updates 50  
FLASH updates 50

### G

gateway  
    configuring 17  
    default address 17

### H

home port 31

### I

initial setup 17  
IP address  
    configuring 17  
    default 17  
    recovering 49

### L

learned networks 31

### M

maintenance 13  
mounting 8  
MS/TP  
    diagnostics capture 46

### N

network  
    termination 9  
    unknown address 49  
    wiring 9

### P

PAD routing 29  
PCAP file 46  
power  
    24 volt 11  
    from transformer 11  
    from USB 11  
power specifications 6  
purge routes 39

### R

recovering IP address 49  
regulatory specifications 6  
replacement parts 7  
Reset Session Timer 24  
route on startup 31  
router core 31  
routing  
    BACnet PAD 29  
    enabled 31  
    Ethernet 30  
    on startup 31

### S

service tool 15  
session timeout 24  
setup 17  
single cable connection  
    as a service tool 15

- for configuration 12
- specifications
  - baud 5
  - environmental 7
  - ethernet 5
  - MS/TP 5
  - power 6
  - regulatory 6
  - timekeeping 7
  - weight 6
- subnet mask
  - configuring 17
  - default 17
- surface mounting 8

**T**

- technician's service tool 15
- telephone number 14
- timekeeping specifications 7
- timeout 24
- transformer wiring 11

**U**

- unknown address 49
- updating firmware 50
- USB
  - power 11
  - service tool connection 15
  - single cable connection 12

**W**

- weight 6
- wiring
  - connecting power 11